

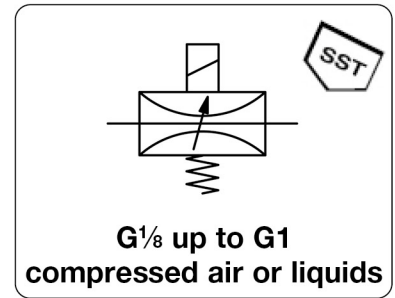

<b>Description</b>	2-way proportional flow valve controls the volume flow of maximum 1185 l/min for air in proportion to the input signal of 0 to 10 V or 0/4 to 20 mA. The proportional valve and the electronic control unit are ordered separately.
<b>Product selection</b>	To achieve the best linear flow characteristics, it is advisable not to reduce the flow too much and to have enough pressure drop at the valve for good control. Reference value: at the valve > 30% of the total pressure drop.
<b>Installation hint</b>	The nominal width of the orifice following the proportional valve should not be smaller than the nominal width of the valve. A constriction of the cross-section after the valve should be categorically avoided!



## General technical features

<b>Design</b>	2-way proportional flow valve, normally closed during absence of current, with additional control module in cable plug or in housing for DIN rail mounting.		
<b>Mounting position</b>	any, preferably upright		
<b>Protection class</b>	IP 65 with coupling socket, IP 40 for DIN rail version		
<b>Temperature range</b>	-10 °C to 90 °C / 14 °F to 194 °F for media -10 °C to 55 °C / 14 °F to 131 °F for electronics		
<b>Material</b>	Body: brass Elastomer:	Inner valve: FKM	brass and stainless steel Control housing: plastic

## Pneumatic features

<b>Media</b>	compressed air, non-corrosive gases or liquids, max. viscosity 21 mm <sup>2</sup> /s, <b>PV40 for liquids only</b>
<b>Operating pressure</b>	see chart, max. 16 bar
<b>Flow rate</b>	0...2 / 1185 l/min for air, 0...0.03 / 83 l/min for liquids in detail see chart, at max. supply pressure and Δp = 1 bar

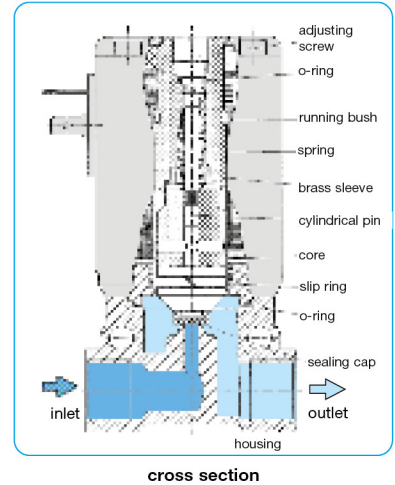

## Electrical features

**Supply voltage** 24 V DC ± 10%, residual ripple max. 5%, with reverse voltage protection

Power consumption	electronic	PV21	PV21	PV22	PV34	PV40-04	PV40-06	PV40-08
	1 W	2 W to DN 0.6	5 W from DN 0.8 on	9 W	16 W	8 W	10 W	15 W

**Command signal** 0-5 V, 0-10 V, 0-20 mA or 4-20 mA selectable

**Impedance** > 20 kΩ at voltage signal  
< 200 Ω at current signal

**Electrical connector** PV21: square connector according to DIN 43650 form B  
PV22...PV40: square connector according to DIN 43650 form A

## Accuracy

<b>Linearity</b>	< 10 % FS		
<b>Hysteresis</b>	< 5 % FS		
<b>Response sensitivity</b>	< 0.1% FS at DN < 0,8 mm,	< 0.25% FS at DN ≥ 0,8 mm,	< 1% FS at PV40
<b>Repeatability</b>	< 0.25% FS at PV22 < 0.5% FS		
<b>Regulating time</b>	PV21: < 15 ms,	PV22: < 20 ms,	PV34: < 50 ms, PV40: < 200 ms each for 90% of the range

## Adjustment

<b>Zero point</b>	The zero point can be decreased or increased.
<b>Range</b>	The range can be decreased or increased.
<b>Ramp</b>	The ramping potentiometer adjusts the time delay with a range of 0 to 10 s in order to dampen sudden changes of the setpoint. Increasing and decreasing ramps have the same delay.
<b>Zero point switch</b>	Using a DIP switch, the zero point switch can be activated or deactivated. It is not necessary to have another switch-off valve.

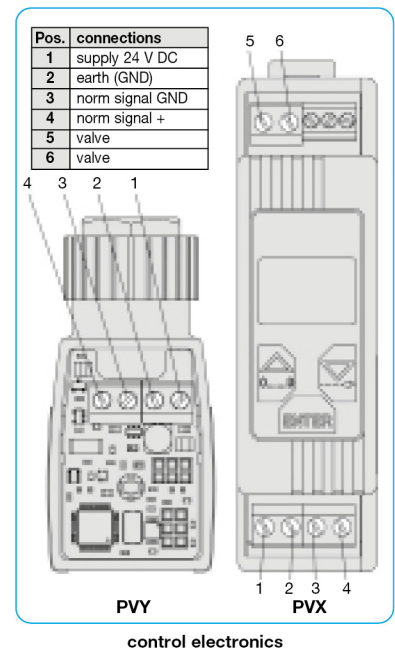

\* Product group





Technical features	
• <b>Media</b>	compressed air, non-corrosive gases or liquids, except for PV40*3
• <b>Signal range</b>	0-5 V, 0-10 V, 0-20 mA, 4-20 mA
• <b>Pressure range</b>	vacuum ... 2 / 16 bar
• <b>Orifice</b>	DN 0.1 ... DN 20
• <b>Flow rate</b>	max. 1185 l/min for air, max. 90 l/min for water
• <b>Adjustment</b>	zero point, range and ramp
• <b>Zero switch-off</b>	ensures reliable closure of the valve
• <b>Linearity</b>	< 10% FS
• <b>Hysteresis</b>	< 5% FS
• <b>Response sensitivity</b>	< 0.1% FS at DN < 0.8 mm < 0.25% FS at DN ≥ 0.8 mm < 1% FS at PV40 < 0.25% FS, < 0.5% FS at PV22
• <b>Repeatability</b>	< 0.25% FS, < 0.5% FS at PV22
• <b>Regulating time</b>	depending on type: < 15 ms, < 20 ms, < 50 ms or < 200 ms
• <b>Protection class</b>	IP65 with plug
• <b>Impedance</b>	> 20 kΩ at V, < 200 Ω at mA

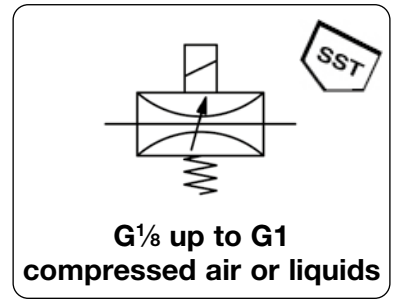

Dimensions			Nominal K <sub>v</sub> -size	Flow rate		Operating pressure	Differ. press.	Connection thread	Order number
A	B	C	value	water	air	max. bar	max. bar	G	
mm	mm	mm	(m <sup>3</sup> /h)	l/min*1	l/min*2				

Proportional flow valve										without electronics, brass, FKM, for compressed air, vacuum or liquids	PV	
25	50	7	0.1	0.0025	0...	0.004	0...	0.27	10	10	G1/8	PV21-01
25	50	7	0.2	0.001	0...	0.017	0...	1.0	10	10	G1/8	PV21-02
25	50	7	0.3	0.002	0...	0.033	0...	2.2	10	10	G1/8	PV21-03
25	50	7	0.4	0.004	0...	0.067	0...	4.0	8	8	G1/8	PV21-04
25	50	7	0.6	0.010	0...	0.167	0...	11	6	6	G1/8	PV21-06
25	50	7	0.8	0.018	0...	0.3	0...	19	12	6	G1/8	PV21-08
25	50	7	0.8	0.018	0...	0.3	0...	19	12	12	G1/8	PV21-08B
25	50	7	1.0	0.027	0...	0.3	0...	19	10	5	G1/8	PV21-10
25	50	7	1.0	0.027	0...	0.3	0...	19	10	10	G1/8	PV21-10B
25	50	7	1.2	0.038	0...	0.633	0...	41	8	4	G1/8	PV21-12
25	50	7	1.2	0.038	0...	0.633	0...	41	8	8	G1/8	PV21-12B
25	50	7	1.6	0.055	0...	0.917	0...	59	6	3	G1/8	PV21-16
25	50	7	1.6	0.055	0...	0.917	0...	59	6	6	G1/8	PV21-16B
25	50	7	2.0	0.090	0...	1.5	0...	97	3	1.5	G1/8	PV21-20
25	50	7	2.0	0.090	0...	1.5	0...	97	3	3	G1/8	PV21-20B
32	66	8.5	0.8	0.018	0...	0.3	0...	19	16	8	G1/8	PV22-08
32	66	8.5	0.8	0.018	0...	0.3	0...	19	16	16	G1/8	PV22-08B
32	66	8.5	1.0	0.027	0...	1.0	0...	65	14	7	G1/8	PV22-10
32	66	8.5	1.0	0.027	0...	1.0	0...	65	14	14	G1/8	PV22-10B
32	66	8.5	1.2	0.040	0...	0.67	0...	43	12	6	G1/8	PV22-12
32	66	8.5	1.2	0.040	0...	0.67	0...	43	12	12	G1/8	PV22-12B
32	66	8.5	1.5	0.060	0...	1.0	0...	65	10	5	G1/8	PV22-15
32	66	8.5	1.5	0.060	0...	1.0	0...	65	10	10	G1/8	PV22-15B
46	72	8.5	2.0	0.10	0...	1.66	0...	108	8	4	G1/4	PV22-20
46	72	8.5	2.0	0.10	0...	1.66	0...	108	8	8	G1/4	PV22-20B
46	72	8.5	2.5	0.15	0...	2.5	0...	162	5	2.5	G1/4	PV22-25
46	72	8.5	2.5	0.15	0...	2.5	0...	162	5	5	G1/4	PV22-25B
46	72	8.5	3.0	0.22	0...	3.67	0...	237	3.5	1.8	G1/4	PV22-30
46	72	8.5	3.0	0.22	0...	3.67	0...	237	3.5	3.5	G1/4	PV22-30B
46	72	8.5	4.0	0.32	0...	5.33	0...	345	2	1	G1/4	PV22-40
46	72	8.5	4.0	0.32	0...	5.33	0...	345	2	2	G1/4	PV22-40B



PV21



PV22

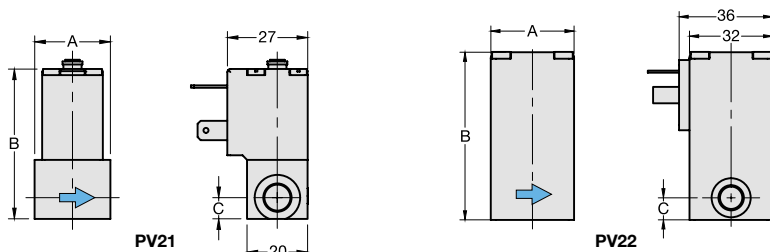

\*1 at max. operating pressure and Δp = 1 bar \*2 at pressure drop from 6 bar down to 5 bar  
\*3 PV40 is not suitable for compressed air and vacuum as it is pilot operated



Media		Technical features	
Media	compressed air, non-corrosive gases or liquids, except for PV40*3	Linearity	< 10% FS
Signal range	0-5 V, 0-10 V, 0-20 mA, 4-20 mA	Hysteresis	< 5% FS
Pressure range	vacuum...2 / 16 bar	Response sensitivity	< 0.1% FS at DN < 0.8 mm < 0.25% FS at DN ≥ 0.8 mm < 1% FS at PV40 < 0.25% FS, < 0.5% FS at PV22
Orifice	DN 0.1 ... DN 20	Repeatability	depending on type: < 15 ms, < 20 ms, < 50 ms or < 200 ms
Flow rate	max. 1185 l/min for air, max. 90 l/min for water	Protection class	IP65 with plug
Adjustment	zero point, range and ramp	Impedance	> 20 kΩ at V, < 200 Ω at mA
Zero switch-off	ensures reliable closure of the valve		

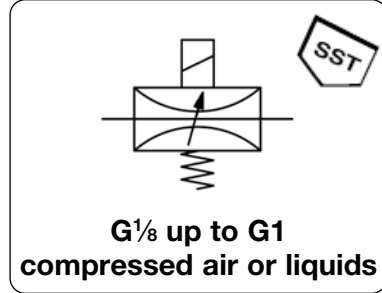

Dimensions			Nominal K <sub>v</sub> -	Flow rate		Operating	Differ.-	Connection	Order	
A	B	C	size	water	air	pressure	press.	thread	number	E*
mm	mm	mm	DN (m <sup>3</sup> /h)	l/min*1	l/min*2	max. bar	max. bar	G		

Proportional flow valve										without electronics, brass, FKM, for compressed air, vacuum or liquids	PV
55	105	11	4.0	0.45	0... 7.5	0... 485	8	4	G <sup>3</sup> / <sub>8</sub>		<b>PV34-40</b>
55	105	11	4.0	0.45	0... 7.5	0... 485	8	8	G <sup>3</sup> / <sub>8</sub>		<b>PV34-40B</b>
55	105	11	6.0	0.80	0... 13.3	0... 860	4	2	G <sup>1</sup> / <sub>2</sub>		<b>PV34-60</b>
55	105	11	6.0	0.80	0... 13.3	0... 860	4	4	G <sup>1</sup> / <sub>2</sub>		<b>PV34-60B</b>
55	105	11	8.0	1.10	0... 18.3	0... 1185	2	1	G <sup>1</sup> / <sub>2</sub>		<b>PV34-80</b>
55	105	11	8.0	1.10	0... 18.3	0... 1185	2	2	G <sup>1</sup> / <sub>2</sub>		<b>PV34-80B</b>
50	89	12	10	1.4	0... 25.0*3	-	10		G <sup>1</sup> / <sub>2</sub>		<b>PV40-04</b>
58	110	14	13	2.5	0... 45.0*3	-	10		G <sup>3</sup> / <sub>4</sub>		<b>PV40-06</b>
80	155	16	20	5.0	0... 90.0*3	-	10		G1		<b>PV40-08</b>



**Special options,** add the appropriate letter  
**stainless steel body** SST 316, W.-No. 1.4401 for PV21 to PV34 PV...S

**Accessories,** enclosed  
**plug electronics** 24 V DC, 0-5 V, 0-10 V, 0/4 mA-20 mA for PV22 to PV40 **PVY-06**  
**clip-on electronics** 24 V DC, 0-5 V, 0-10 V, 0/4 mA-20 mA for PV21 **PVX-01**  
for PV22 to PV40 **PVX-02**  
**coupling socket** according to DIN 43650 form B for PV21 **2285-0**  
according to DIN 43650 form A for PV22 to PV40 **2286-0**

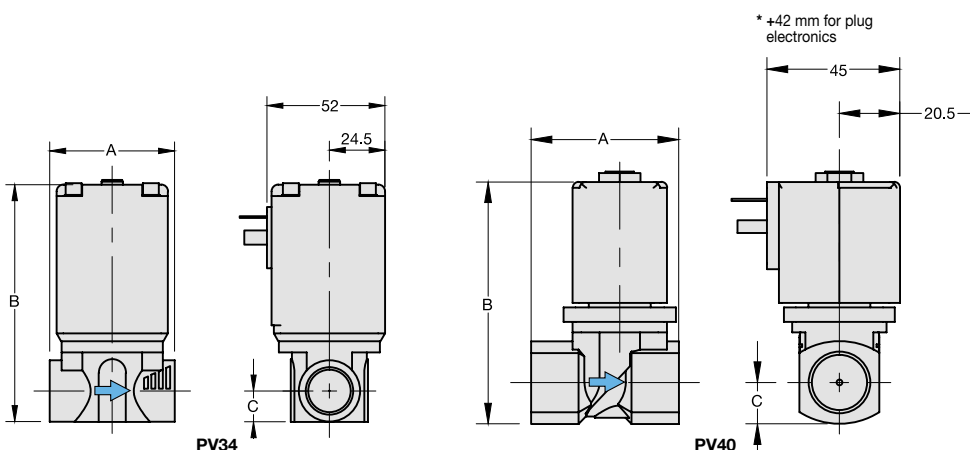

\*1 at max. operating pressure and Δp = 1 bar \*2 at pressure drop from 6 bar down to 5 bar  
\*3 PV40 is not suitable for compressed air and vacuum as it is pilot operated